

Article number: 4320000751

Description: Rota-fix shaft-hub connection A 75x115
Stainless Steel

Measures

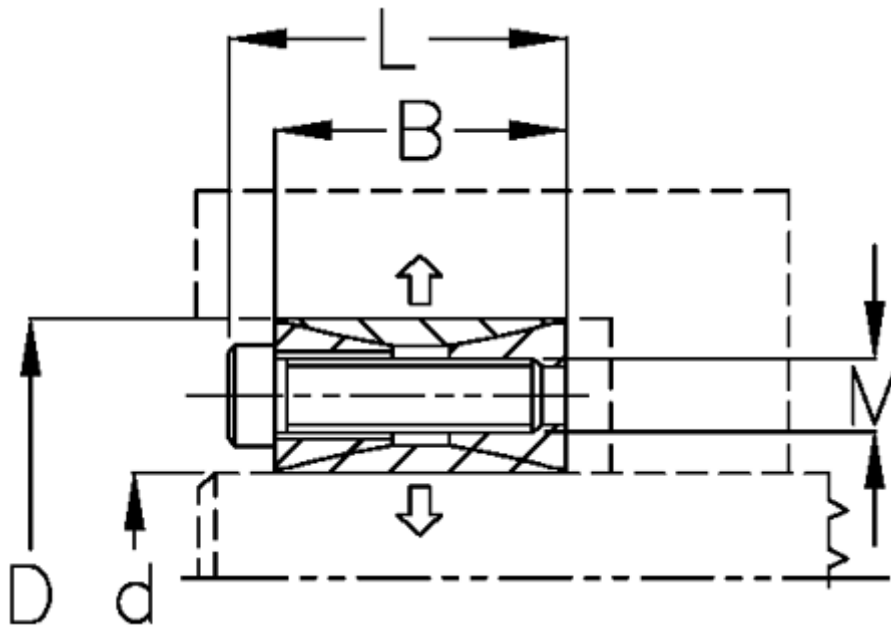

B mm	= 28
d H8 mm	= 75
D mm	= 115
Fit tolerance	= Aksel k11-h11, Nav N11-H11
F kN torque	= 84.0
L mm	= 38
M mm	= M10
P N/mm ² surface pressure on shaft/hub	= 49

Surface roughness	=
T N m torque	=
Ts N m bolt tightening torque	=